

 **ANCHOR**

by **Panasonic**

**ziva**  
Meets Every Standard

**MEETS  
EVERY  
STANDARD**



**PRICELIST: JULY 2023**



Ziva is a series of modular switches designed at an economic price range. It's slim and sleek design will raise the beauty of your home by leaps and bounds. They also have a long life span and can be placed both horizontally and vertically, according to your choice.

### ▶ Vertical & Horizontal Installation

- Can be mounted vertically or horizontally
- Vertically mounted plates can fit in any space constraints
- Looks trendy & young

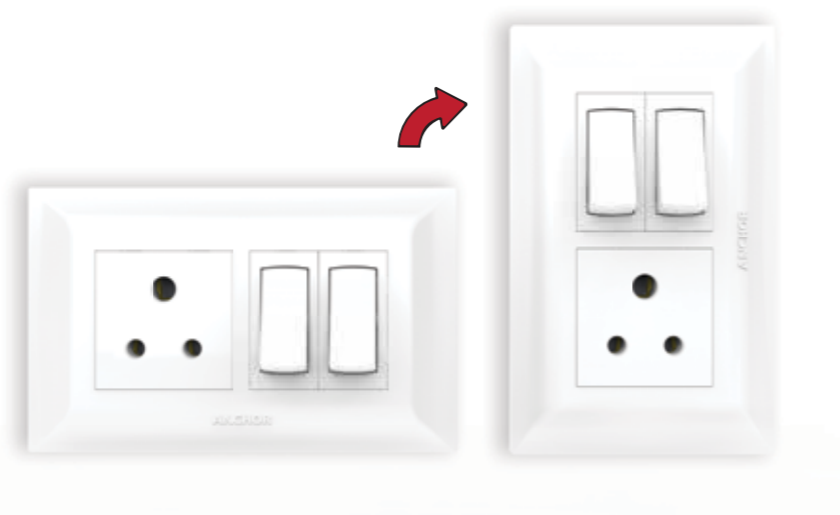

### ▶ Two Plate Design & Single Mounting Plate Design



Two Plate Design



Single Mounting Plate Design

### ▶ Slim & Elegant Design

- Great aesthetic
- Blends with the wall and gives a very sleek look

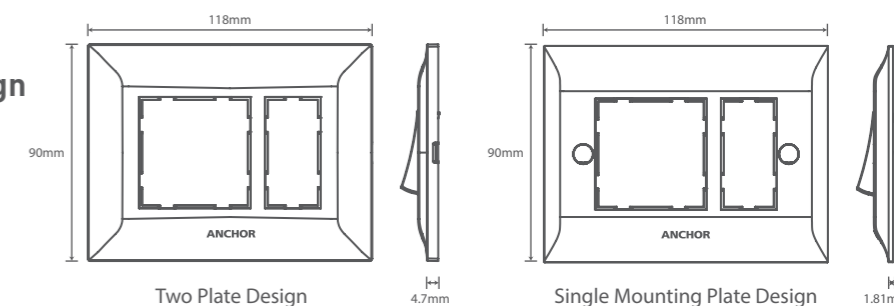

### ▶ 1 Lac Operations

- Long Operational Life
- No need to worry for years to come

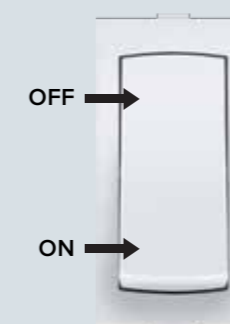

### ▶ Captive Screws

- Screws do not fall away
- Avoid screw driver slippage

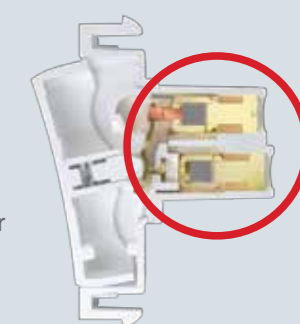

### ▶ IP20 Protection

- No live part is exposed to fingers and can be accessible only through screw driver
- Protects against solid object larger than 12mm

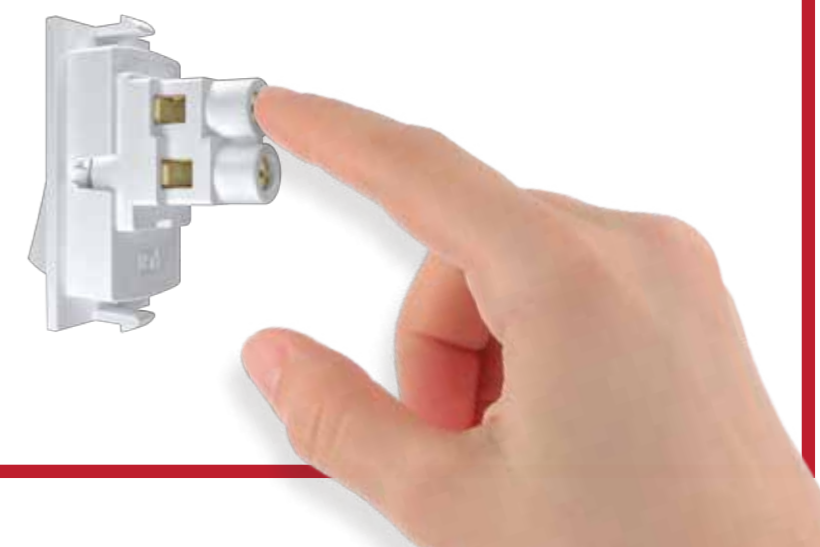

**WHITE**

Item	Description	HSN	Unit Sale Price Rs per number	Standard Packing Quantity (Number)	Maximum Retail Price (Inclusive of all taxes) Rs.
<b>SWITCHES</b>					
68001	6A, 1Way Switch , 1 Module (ISI)	85361010	32	20	640
68002	6A, 2Way Switch , 1 Module (ISI)	85361010	61	20	1220
68003	6A, Bell Push Switch , 1 Module (ISI)	85361010	64	20	1280
68066	6A, Bell Push Switch with Indicator , 2 Module (ISI)	85361010	93	10	930
68007	16A, 1Way Switch, 1 Module (ISI)	85361020	77	10	770
68008	16A, 2Way Switch, 1 Module (ISI)	85361020	103	10	1030
68077	16A, 1Way Switch with Indicator, 1 Module (ISI)	85361020	84	10	840
68025	25A, SP 1 Way Switch with Indicator, 1 Module (ISI)	85361020	105	10	1050
68032	32A, DP 1Way Switch with Indicator, 2 Module (ISI)	85361020	184	10	1840
<b>SOCKET</b>					
68208	6A, 3 Pin Round Socket without Shutter, 2 Module, ISI	85366910	62	10	620
68205	6A/16A,Twin Socket, 2 Module (ISI)	85366910	135	10	1350
<b>FAN REGULATOR</b>					
68301	100W ,4 Step Fan regulator, 1 Module	84149030	281	20	5620
68302	100W , 5 Step Fan regulator, 2 Module	84149030	324	10	3240
68322	100W , 5 Step Fan regulator, 2 Module, ISI (Electronic Type)	84149030	342	10	3420
<b>DIMMER</b>					
68401	450W, Dimmer, 1 Module (For Incandescent Lamp)	85365020	295	20	5900
68402	650W, Dimmer, 2 Module (For Incandescent Lamp)	85365020	385	10	3850
<b>COMMUNICATION AND DATA SOCKET</b>					
68501	Cord Outlet, 1 Module	85366910	63	20	1260
68502	TV Socket Outlet ,1 Module	85365090	84	10	840
68610	RJ11, Tel Jack with Shutter, 1 Module	85366910	101	10	1010
68620	RJ45, Receptor, 1 Module	85366910	124	20	2480
68622	RJ45, Computer Jack, Cat6, 1 Module	85444299	532	10	5320
<b>SUPPORT FUNCTION &amp; HOSPITALITY RANGE</b>					
68503	Blank Plate, (Dimensions: LXH ,2.3cm X 4.6cm ), 1 Module	85389000	18	50	900
68504	LED Indicator (Red), 1 Module	85318000	70	10	700
68505	USB-A Charger, Single Port(2.1A, 5V DC), 1 Module	85044090	936	10	9360
68508	6A, Overload Protection - Manual Resettable Fuse, 1 Module	85361060	129	20	2580
68509	16A, Overload Protection - Manual Resettable Fuse, 1 Module	85361060	155	20	3100
68710	Buzzer, 2 Module	85318000	157	10	1570
68125	Motor Starter Switch, 25A 240V~50Hz, SP	85369010	394	10	3940
68705	Foot Light-LED Based (Cool Day Light) 2M,240V~	94054090	411	10	4110
68706	Foot Light-LED Based (Warm White Light) 2M,240V~	94054090	411	10	4110
68701	32A, DP Switch unit with keytag, 2 Module	85365090	463	10	4630
68702	Only Keytag with Ring	85365090	77	15	1155
68708	DND MMR Internal unit without Plate (DND Switch, MMR Switch), 2 Module	85365090	278	1	278
68709	DND MMR External unit without Plate (DND Indicator, MMR Indicator & Bell Push Switch), 3 Module	85365090	411	1	411



68001 68007 68002 68008 68003 68077



68066 68025 68032



68208 68205



68301 68302 68401 68402 68322



68501 68502 68610 68620 68622



68503 68504 68505 68508 68509 68710



68125 68705 68706 68701 68702



68708 68709

16A,20A,25A Switch not suggested for geyser load. Instead MCB/Motor Stater must be used.

**BLACK**

Item	Description	HSN	Unit Sale Price Rs per number	Standard Packing Quantity (Number)	Maximum Retail Price (Inclusive of all taxes) Rs.
<b>SWITCHES</b>					
68001B	6A, 1Way Switch , 1 Module (ISI)	85361010	39	20	780
68002B	6A, 2Way Switch , 1 Module (ISI)	85361010	77	20	1540
68003B	6A, Bell Push Switch , 1 Module (ISI)	85361010	81	20	1620
68066B	6A, Bell Push Switch with Indicator , 2 Module (ISI)	85361010	115	10	1150
68007B	16A, 1Way Switch, 1 Module (ISI)	85361020	96	10	960
68008B	16A, 2Way Switch, 1 Module (ISI)	85361020	129	10	1290
68077B	16A, 1Way Switch with Indicator, 1 Module (ISI)	85361020	106	10	1060
68025B	25A, SP 1 Way Switch with Indicator, 1 Module (ISI)	85361020	132	10	1320
68032B	32A, DP 1Way Switch with Indicator, 2 Module (ISI)	85361020	231	10	2310
<b>SOCKET</b>					
68208B	6A, 3 Pin Round Socket without Shutter, 2 Module, ISI	85366910	77	10	770
68205B	6A/16A,Twin Socket, 2 Module (ISI)	85366910	169	10	1690
<b>FAN REGULATOR</b>					
68301B	100W ,4 Step Fan regulator, 1 Module	84149030	351	20	7020
68302B	100W , 5 Step Fan regulator, 2 Module	84149030	406	10	4060
68322B	100W , 5 Step Fan regulator, 2 Module, ISI (Electronic Type)	84149030	427	10	4270
<b>DIMMER</b>					
68401B	450W, Dimmer, 1 Module (For Incandescent Lamp)	85365020	367	20	7340
68402B	650W, Dimmer, 2 Module (For Incandescent Lamp)	85365020	481	10	4810
<b>COMMUNICATION AND DATA SOCKET</b>					
68501B	Cord Outlet, 1 Module	85366910	80	20	1600
68502B	TV Socket Outlet ,1 Module	85365090	107	10	1070
68610B	RJ11, Tel Jack with Shutter, 1 Module	85365090	129	10	1290
68620B	RJ45, Receptor, 1 Module	85365090	156	20	3120
68622B	RJ45, Computer Jack, Cat6, 1 Module	85444299	664	10	6640
<b>SUPPORT FUNCTION</b>					
68503B	Blank Plate, (Dimensions: LXH ,2.3cm X 4.6cm ), 1 Module	85389000	22	50	1100
68504B	LED Indicator (Red), 1 Module	85318000	89	10	890
68505B	USB-A Charger, Single Port(2.1A, 5V DC), 1 Module	85044090	1170	10	11700
68508B	6A, Overload Protection - Manual Resettable Fuse, 1 Module	85361060	161	20	3220
68509B	16A, Overload Protection - Manual Resettable Fuse, 1 Module	85361060	193	20	3860
68710B	Buzzer, 2 Module	85318000	196	10	1960
68125B	Motor Starter Switch, 25A 240V~50Hz, SP	85369010	431	10	4310
68705B	Foot Light-LED Based (Cool Day Light) 2M,240V~	94054090	513	10	5130
68706B	Foot Light-LED Based (Warm White Light) 2M,240V~	94054090	513	10	1100
68701B	32A, DP Switch unit with keytag, 2 Module	85365090	579	10	5790
68702B	Only Keytag with Ring	85365090	97	15	1455
68708B	DND MMR Internal unit without Plate (DND Switch, MMR Switch), 2 Module	85365090	345	1	345
68709B	DND MMR External unit without Plate (DND Indicator, MMR Indicator & Bell Push Switch), 3 Module	85365090	513	1	513

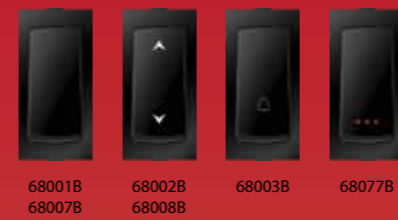

68001B 68007B 68002B 68008B 68003B 68077B



68066B 68025B 68032B



68208B 68205B



68301B 68302B 68401B 68402B 68322B



68501B 68502B 68610B 68620B 68622B



68503B 68504B 68505B 68508B 68509B 68710B



68125B 68705B 68706B 68701B 68702B



68708B 68709B

16A,20A,25A Switch not suggested for geyser load. Instead MCB/Motor Stater must be used.



SINGLE MOUNTING PLATE (HSN Code - 85381090)										
MODULE	1 Module	2 Module	3 Module	4 Module	6 Module	8 Module Horizontal	8 Module Vertical	12 Module	16 Module	18 Module
Code	68801	68802	68803	68804	68806	68808	68888	68812	68816	68818
<b>Unit Sale Price Rs per number</b>	<b>48</b>	<b>48</b>	<b>59</b>	<b>72</b>	<b>98</b>	<b>127</b>	<b>128</b>	<b>156</b>	<b>180</b>	<b>197</b>
Maximum Retail Price (Inclusive of all taxes) Rs.	960	960	1180	1440	980	1270	640	780	900	985
Standard Packing Quantity (Number)	20	20	20	20	10	10	5	5	5	5

TWO PLATE DESIGN - COVER PLATE WITH BASE FRAME (HSN Code - 85381090)										
MODULE	1 Module	2 Module	3 Module	4 Module	6 Module	8 Module Horizontal	8 Module Vertical	12 Module	16 Module	18 Module
Code	68901	68902	68903	68904	68906	68908	68988	68912	68916	68918
<b>Unit Sale Price Rs per number</b>	<b>64</b>	<b>64</b>	<b>72</b>	<b>90</b>	<b>117</b>	<b>159</b>	<b>159</b>	<b>196</b>	<b>220</b>	<b>236</b>
Maximum Retail Price (Inclusive of all taxes) Rs.	1280	1280	1440	1800	1170	1590	795	980	1100	1180
Standard Packing Quantity (Number)	20	20	20	20	10	10	5	5	5	5



BLACK - COVER PLATE WITH BASE FRAME (HSN Code - 85381090)										
MODULE	1 Module	2 Module	3 Module	4 Module	6 Module	8 Module Horizontal	8 Module Vertical	12 Module	16 Module	18 Module
Code	68901B	68902B	68903B	68904B	68906B	68908B	68988B	68912B	68916B	68918B
<b>Unit Sale Price Rs per number</b>	<b>82</b>	<b>82</b>	<b>94</b>	<b>114</b>	<b>155</b>	<b>207</b>	<b>207</b>	<b>257</b>	<b>286</b>	<b>307</b>
Maximum Retail Price (Inclusive of all taxes) Rs.	1640	1640	1880	2280	1550	2070	1035	1285	1430	1535
Standard Packing Quantity (Number)	20	20	20	20	10	10	5	5	5	5

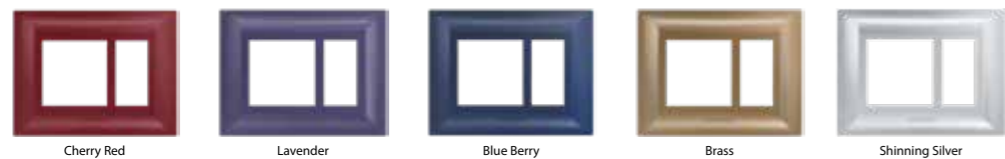

COLOR PLATES - COVER PLATE WITH BASE FRAME (HSN Code - 85381090)										
MODULE	1 Module	2 Module	3 Module	4 Module	6 Module	8 Module Horizontal	8 Module Vertical	12 Module	16 Module	18 Module
Cherry Red	68901CR	68902CR	68903CR	68904CR	68906CR	68908CR	68988CR	68912CR	68916CR	68918CR
Lavender	68901LD	68902LD	68903LD	68904LD	68906LD	68908LD	68988LD	68912LD	68916LD	68918LD
Blue Berry	68901BB	68902BB	68903BB	68904BB	68906BB	68908BB	68988BB	68912BB	68916BB	68918BB
Brass	68901BR	68902BR	68903BR	68904BR	68906BR	68908BR	68988BR	68912BR	68916BR	68918BR
Shinning Silver	68901SS	68902SS	68903SS	68904SS	68906SS	68908SS	68988SS	68912SS	68916SS	68918SS
<b>Unit Sale Price Rs per number</b>	<b>86</b>	<b>86</b>	<b>98</b>	<b>122</b>	<b>161</b>	<b>217</b>	<b>217</b>	<b>268</b>	<b>300</b>	<b>320</b>
Maximum Retail Price (Inclusive of all taxes) Rs.	1720	1720	1960	2440	1610	2170	1085	1340	1500	1600
Standard Packing Quantity (Number)	20	20	20	20	10	10	5	5	5	5



WHITE & BLACK PLATE WITH CHROME COLLAR - COVER PLATE WITH BASE FRAME (HSN Code - 85381090)										
MODULE	1 Module	2 Module	3 Module	4 Module	6 Module	8 Module Horizontal	8 Module Vertical	12 Module	16 Module	18 Module
Chrome Collar - White	68901-C	68902-C	68903-C	68904-C	68906-C	68908-C	68988-C	68912-C	68916-C	68918-C
Golden Collar - White	68901-G	68902-G	68903-G	68904-G	68906-G	68908-G	68988-G	68912-G	68916-G	68918-G
<b>Unit Sale Price Rs per number</b>	<b>77</b>	<b>77</b>	<b>85</b>	<b>107</b>	<b>143</b>	<b>191</b>	<b>191</b>	<b>238</b>	<b>265</b>	<b>284</b>
Maximum Retail Price (Inclusive of all taxes) Rs.	1540	1540	1700	2140	1430	1910	955	1190	1325	1420
Chrome Collar - Black	68901B-C	68902B-C	68903B-C	68904B-C	68906B-C	68908B-C	68988B-C	68912B-C	68916B-C	68918B-C
Golden Collar - Black	68901B-G	68902B-G	68903B-G	68904B-G	68906B-G	68908B-G	68988B-G	68912B-G	68916B-G	68918B-G
<b>Unit Sale Price Rs per number</b>	<b>99</b>	<b>99</b>	<b>112</b>	<b>138</b>	<b>187</b>	<b>249</b>	<b>249</b>	<b>307</b>	<b>345</b>	<b>368</b>
Maximum Retail Price (Inclusive of all taxes) Rs.	1980	1980	2240	2760	1870	2490	1245	1535	1725	1840
Standard Packing Quantity (Number)	20	20	20	20	10	10	5	5	5	5



PLATES SUITABLE FOR WOODEN BOXES (HSN Code - 85381090)														
MODULE	1 Module	2 Module	3 Module	4 Module	6 Module	8 Module Horizontal	8 Module Vertical	10 Module Horizontal	12 Module Horizontal	12 Module Vertical	16 Module	18 Module	20 Module	24 Module
White	68551-C	68552-C	68553-C	68554-C	68556-C	68558-C	68588-C	68560-C	68562-C	68512-C	68516-C	68518-C	68520-C	68524-C
<b>Unit Sale Price Rs per number</b>	<b>81</b>	<b>81</b>	<b>95</b>	<b>116</b>	<b>158</b>	<b>211</b>	<b>211</b>	<b>236</b>	<b>260</b>	<b>260</b>	<b>290</b>	<b>314</b>	<b>345</b>	<b>477</b>
Maximum Retail Price (Inclusive of all taxes) Rs.	1620	1620	1900	2320	1580	2110	1055	2360	2600	1300	1450	1570	1725	2385
Cherry Red	68551CR-C	68552CR-C	68553CR-C	68554CR-C	68556CR-C	68558CR-C	68588CR-C	68560CR-C	68562CR-C	68512CR-C	68516CR-C	68518CR-C	68520CR-C	68524CR-C
Blue Berry	68551BB-C	68552BB-C	68553BB-C	68554BB-C	68556BB-C	68558BB-C	68588BB-C	68560BB-C	68562BB-C	68512BB-C	68516BB-C	68518BB-C	68520BB-C	68524BB-C
<b>Unit Sale Price Rs per number</b>	<b>112</b>	<b>112</b>	<b>130</b>	<b>161</b>	<b>217</b>	<b>290</b>	<b>290</b>	<b>325</b>	<b>359</b>	<b>359</b>	<b>400</b>	<b>432</b>	<b>475</b>	<b>700</b>
Maximum Retail Price (Inclusive of all taxes) Rs.	2240	2240	2600	3220	2170	2900	1450	3250	3590	1795	2000	2160	2375	3500
Standard Packing Quantity (Number)	20	20	20	20	10	10	5	10	10	5	5	5	5	5
Dimension in cm ( W x H)	11.5 x 11.5	11.5 x 11.5	13.5 x 11.5	16.5 x 11.5	22 x 11.5	27 x 11.5	16.5 x 16.5	32.5 x 11.5	39.2 x 11.5	22 x 16.5	27 x 16.5	27 x 23	32.5 x 16.5	32.5 x 16.5

SURFACE BOX WITH PLATE (HSN Code - 85381090)										
MODULE	1 Module	2 Module	3 Module	4 Module	6 Module	8 Module Horizontal	8 Module Vertical	12 Module	16 Module	18 Module
Code	68451	68452	68453	68454	68456	68458	68488	68412	68416	68418
<b>Unit Sale Price Rs per number</b>	<b>114</b>	<b>114</b>	<b>139</b>	<b>172</b>	<b>229</b>	<b>300</b>	<b>300</b>	<b>366</b>	<b>423</b>	<b>463</b>
Maximum Retail Price (Inclusive of all taxes) Rs.	1140	1140	1390	1720	2290	1500	1500	1830	2115	2315
Standard Packing Quantity (Number)	10	10	10	10	10	5	5	5	5	5



Note : Do not use "Hard Cleaning Agent" for cleaning purpose.



Item	Description	HSN	Unit Sale Price Rs per number	Standard Packing Quantity (Number)	Maximum Retail Price (Inclusive of all taxes) Rs.
<b>MINI MCB SP</b>					
68980	6A SP "C" Ziva Mini MCB	85362030	281	12	3372
68981	10A SP "C" Ziva Mini MCB	85362030	281	12	3372
68982	16A SP "C" Ziva Mini MCB	85362030	281	12	3372
68983	20A SP "C" Ziva Mini MCB	85362030	281	12	3372
68984	25A SP "C" Ziva Mini MCB	85362030	281	12	3372
68985	32A SP "C" Ziva Mini MCB	85362030	281	12	3372
<b>MINI MCB DP</b>					
68989	6A DP "C" Ziva Mini MCB	85362030	568	6	3408
68990	10A DP "C" Ziva Mini MCB	85362030	568	6	3408
68991	16A DP "C" Ziva Mini MCB	85362030	568	6	3408
68992	20A DP "C" Ziva Mini MCB	85362030	568	6	3408
68993	25A DP "C" Ziva Mini MCB	85362030	568	6	3408
68994	32A DP "C" Ziva Mini MCB	85362030	568	6	3408



#### TERMS AND CONDITIONS

- 1) Prices are in INR (₹).
- 2) All prices are subject to the general terms and conditions of our business.
- 3) Prices are subject to change without prior notice.
- 4) This price list supersedes all our previous price lists.
- 5) If any dispute should arise it will be subject to Thane jurisdiction.
- 6) Company reserves the right to issue amendments which may arise due to any errors in the price list.
- 7) Colour in images are for reference purpose only, please see product for actual colour.

Due to continuous improvements in product design and development and manufacturing methods, the product may differ in some aspects from the details provided herein.

#### PANASONIC LIFE SOLUTIONS INDIA PVT. LTD.

**Corporate & Head Office:** 3rd Floor, B Wing, I-Think Techno Campus, Pokharan Road No.2, Thane (W), Thane - 400 607, Maharashtra.

Tel. 022 4222 8888 | Fax. 022 4222 8884

Customer Care no.: 022-41304130 | WhatsApp: 9136028606

Email: [wecare@in.panasonic.com](mailto:wecare@in.panasonic.com) | [www.isin.panasonic.com](http://www.isin.panasonic.com)

**Registered Office:** 12th Floor, Ambience Tower, Ambience Island, NH-48, Gurugram - 122 002, Haryana.

Distributor / Dealer Stamp